

Exploded diagram and spare parts list

For machines with - CF761-04

[Click](#)







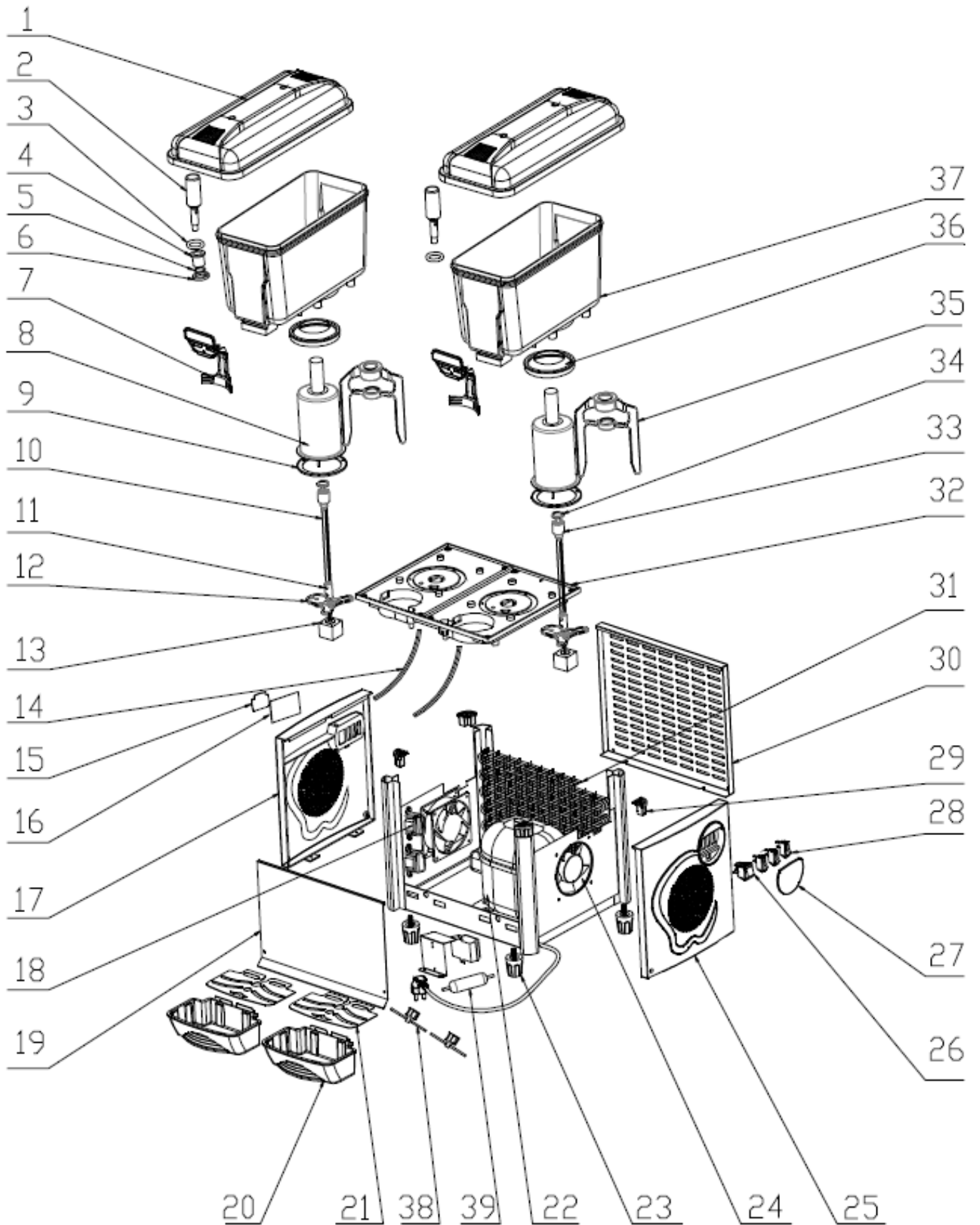

From 5089516-UK(S/N:KL191581906D1647~KL191581906D1723),
onward

For machines with – CF761

[Click](#)

Prior to 5089516-UK(S/N:KL191581906D1647~KL191581906D1723)





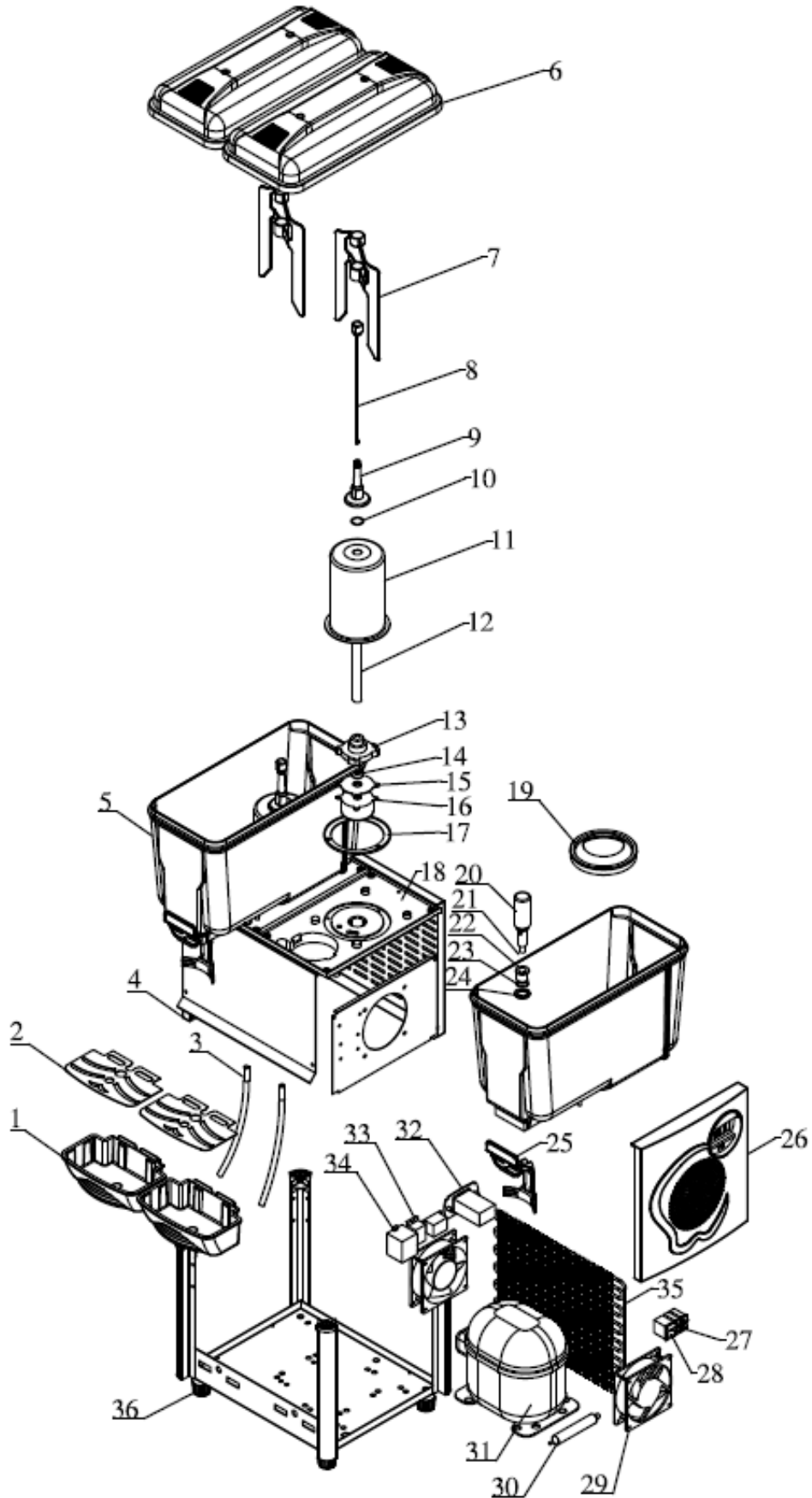



Machine	Explode	Code	Description
Polar Double Chilled Drinks Dispenser Grey	1	AJ201	Cover
Polar Double Chilled Drinks Dispenser Grey	2	AB933	Stainless Steel Valve
Polar Double Chilled Drinks Dispenser Grey	3	AB555	Tap Gasket
Polar Double Chilled Drinks Dispenser Grey	4	AL898	Outlet
Polar Double Chilled Drinks Dispenser Grey	5	AL899	Seal of Outlet
Polar Double Chilled Drinks Dispenser Grey	6	AL900	Screw of Outlet
Polar Double Chilled Drinks Dispenser Grey	7	AG909	Tap Lever
Polar Double Chilled Drinks Dispenser Grey	8		Tank Evaporator - From 5089516-UK
Polar Double Chilled Drinks Dispenser Grey	9		Washer of Evaporator
Polar Double Chilled Drinks Dispenser Grey	10	AM794	Mixing Pod - From 5089516-UK
Polar Double Chilled Drinks Dispenser Grey	11	AN339	Driveshaft Coupler - From 5089516-UK
Polar Double Chilled Drinks Dispenser Grey	12		Motor Mounting Plate - From 5089516-UK
Polar Double Chilled Drinks Dispenser Grey	13	AK040	Stepped Motor - From 5089516-UK
Polar Double Chilled Drinks Dispenser Grey	14	AM620	Drain Pipe
Polar Double Chilled Drinks Dispenser Grey	15	AK041	Thermostat Sticker
Polar Double Chilled Drinks Dispenser Grey	16	AK043	Thermostat
Polar Double Chilled Drinks Dispenser Grey	17	AM621	Left Side Panel of Controller Side
Polar Double Chilled Drinks Dispenser Grey	18	AK044	Transformer - From 5089516-UK
Polar Double Chilled Drinks Dispenser Grey	19	AM795	Front Plate
Polar Double Chilled Drinks Dispenser Grey	20	AJ070	Water Tray
Polar Double Chilled Drinks Dispenser Grey	21	AJ200	Lid of Water Tray
Polar Double Chilled Drinks Dispenser Grey	22	AG672	Compressor (R290)
Polar Double Chilled Drinks Dispenser Grey	22	AN861	Compressor (R290)-From CF761-05
Polar Double Chilled Drinks Dispenser Grey	23	AL192	Adjustable Feet
Polar Double Chilled Drinks Dispenser Grey	24	AJ202	Condenser Fan Motor
Polar Double Chilled Drinks Dispenser Grey	25	AN354	Right Side Panel
Polar Double Chilled Drinks Dispenser Grey	26	AE596	Power Switch
Polar Double Chilled Drinks Dispenser Grey	27		Cover for Switch
Polar Double Chilled Drinks Dispenser Grey	N/A	AL981	Switch Box
Polar Double Chilled Drinks Dispenser Grey	28	AE841	Switch for Motor
Polar Double Chilled Drinks Dispenser Grey	29		Corner Plug
Polar Double Chilled Drinks Dispenser Grey	30		Back Panel
Polar Double Chilled Drinks Dispenser Grey	31		Condenser
Polar Double Chilled Drinks Dispenser Grey	32		Roof
Polar Double Chilled Drinks Dispenser Grey	33	AN614	Rotor - From 5089516-UK
Polar Double Chilled Drinks Dispenser Grey	34	AN615	Rotor Positioning Plate - From 5089516-UK
Polar Double Chilled Drinks Dispenser Grey	35	AK045	Paddle - From 5089516-UK
Polar Double Chilled Drinks Dispenser Grey	36	AB557	Tank Gasket
Polar Double Chilled Drinks Dispenser Grey	37	AJ071	High-Density PC Bowl (Paddle System)
Polar Double Chilled Drinks Dispenser Grey	38	AK046	Electronic Expansive Valve & Coil - From 5089516-UK
Polar Double Chilled Drinks Dispenser Grey	39	AG674	Filter Drier
Polar Double Chilled Drinks Dispenser Grey	N/A		Temp Sensor



Exploded diagram and spare parts list

(CF761)

Machine	Explode	Code	Description
Polar Double Chilled Drinks Dispenser Grey	1	AJ070	Water Tray
Polar Double Chilled Drinks Dispenser Grey	2	AJ200	Lid of Water Tray
Polar Double Chilled Drinks Dispenser Grey	3	AM620	Drain Pipe
Polar Double Chilled Drinks Dispenser Grey	4	AM621	Left Side Panel
Polar Double Chilled Drinks Dispenser Grey	5	AJ071	High-density PC Bowl (Paddle system)
Polar Double Chilled Drinks Dispenser Grey	6	AJ201	Cover
Polar Double Chilled Drinks Dispenser Grey	7	AB553	Mixing Paddle
Polar Double Chilled Drinks Dispenser Grey	8	AB558	Mixing Paddle Rod
Polar Double Chilled Drinks Dispenser Grey	9	AL436	Mixing Pod
Polar Double Chilled Drinks Dispenser Grey	10	AL437	Seal of Rod in Evaporator
Polar Double Chilled Drinks Dispenser Grey	11	AL438	Tank Evaporator
Polar Double Chilled Drinks Dispenser Grey	12	AL439	Rod in Evaporator
Polar Double Chilled Drinks Dispenser Grey	13		Cock of Mixing motor
Polar Double Chilled Drinks Dispenser Grey	14		Seal of mixing motor
Polar Double Chilled Drinks Dispenser Grey	15		Cover of Mixing Motor
Polar Double Chilled Drinks Dispenser Grey	16	AB560	Mixing Motor
Polar Double Chilled Drinks Dispenser Grey	17		Washer of Evaporator
Polar Double Chilled Drinks Dispenser Grey	18		Roof
Polar Double Chilled Drinks Dispenser Grey	19	AB557	Tank Gasket
Polar Double Chilled Drinks Dispenser Grey	20	AB933	Stainless Steel Valve
Polar Double Chilled Drinks Dispenser Grey	21	AB555	Tap Gasket
Polar Double Chilled Drinks Dispenser Grey	22	AL898	Outlet
Polar Double Chilled Drinks Dispenser Grey	23	AL899	Seal of Outlet
Polar Double Chilled Drinks Dispenser Grey	24	AL900	Screw of Outlet
Polar Double Chilled Drinks Dispenser Grey	25	AG909	Tap Lever
Polar Double Chilled Drinks Dispenser Grey	26	AN354	Right Side Panel
Polar Double Chilled Drinks Dispenser Grey	27	AE841	Switch for Mixing Motor
Polar Double Chilled Drinks Dispenser Grey	28	AE596	Power Switch
Polar Double Chilled Drinks Dispenser Grey	29	AJ202	Fan Motor
Polar Double Chilled Drinks Dispenser Grey	30	AG674	Filter Drier
Polar Double Chilled Drinks Dispenser Grey	31	AG672	Compressor(R290)
Polar Double Chilled Drinks Dispenser Grey	32	AJ203	Thermostat
Polar Double Chilled Drinks Dispenser Grey	33	AJ204	Relay
Polar Double Chilled Drinks Dispenser Grey	34	AJ069	Transformer
Polar Double Chilled Drinks Dispenser Grey	35		Condenser
Polar Double Chilled Drinks Dispenser Grey	36	AL192	Adjustable Leg